

OLYMPUS[®]

Your Vision Our Future

RESEARCH STEREOMICROSCOPE SYSTEM

SZX16 / SZX10



For Industrial Use



LECO Corporation • 800-292-6141 • www.leco.com
Form No. 209-181 1/07

Olympus has acquired ISO9001/ISO14001 certification for its quality/environmental management systems.
Specifications are subject to change without any obligation on the part of the manufacturer.

OLYMPUS[®]

www.olympus.com

OLYMPUS CORPORATION
Shinjuku Monolith, 3-1, Nishi Shinjuku 2-chome, Shinjuku-ku, Tokyo, Japan
OLYMPUS LIFE AND MATERIAL SCIENCE EUROPA GMBH
Postfach 10 49 08, 20034, Hamburg, Germany
OLYMPUS SURGICAL & INDUSTRIAL AMERICA INC.
One Corporate Drive, Orangeburg, NY 10962, U.S.A.
OLYMPUS UK LTD.
2-8 Honduras Street, London EC1Y 0TX, United Kingdom.

OLYMPUS AUSTRALIA PTY. LTD.
31 Gibby Road, Mt. Waverley, VIC 3149, Melbourne, Australia.
OLYMPUS LATIN AMERICA, INC.
6100 Blue Lagoon Drive, Suite 390 Miami, FL 33126-2087, U.S.A.

Reaching a new dimension of microscopy — beyond the imagination.

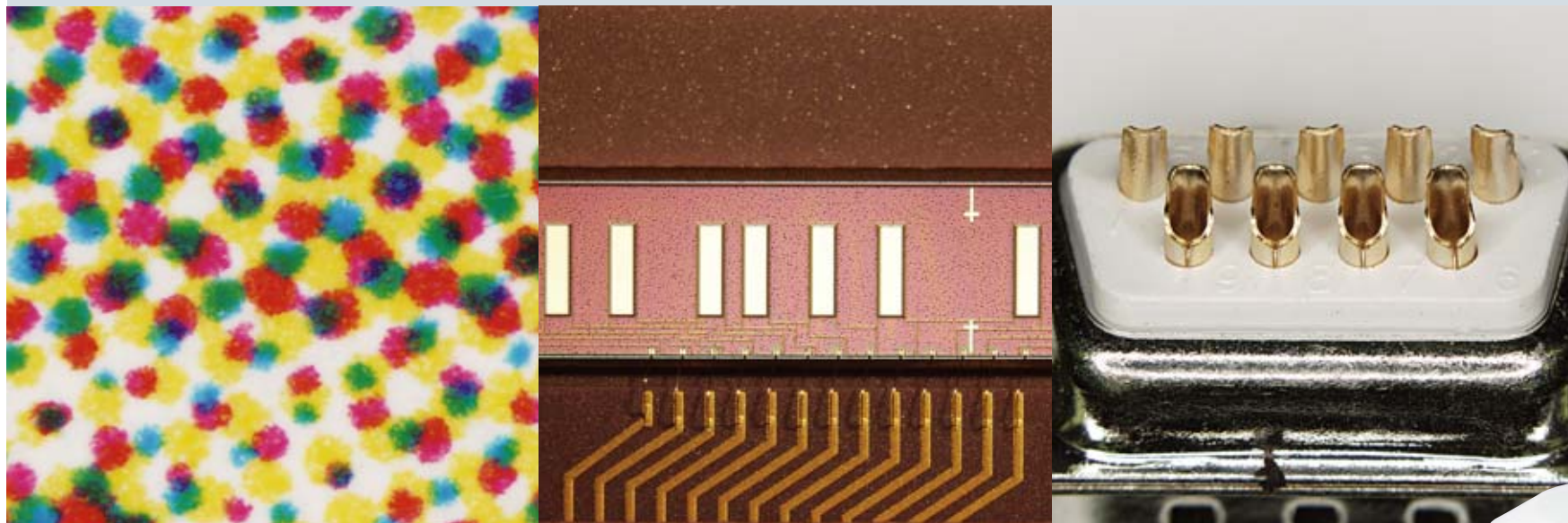

Fine optical performance at the highest level of stereomicroscopes. Operability designed to be user-friendly. Full response to the need for digital imaging that supports a variety of tasks from observation to analysis. Highly responsive with refined optics, the SZX Research Stereomicroscope enhances the efficiency required for cutting-edge industrial R&D and quality analysis.

- Refined optical performance p3-p8
- Ergonomic design for working comfort p9-p10
- Varied illumination technology p11-p14
- Intelligent digital imaging p15-p17

The SZX series is the result of steadily pursuing ultra-refined Galilean optics — the industry standard of optical systems for advanced stereomicroscopy. The lineup is designed to increase power for obtaining the highest zoom quality during macro observation at low magnification, as well as microstructural observation at high magnification. Enhanced power also is assured by the world's highest zoom range and increased focal depth. Observations by parallel light paths and by digital imaging, plus ease of use, are features that realize the full potential of stereomicroscopy.

In the past, single objective magnifications as high as 200x were only possible with conventional compound microscopes. With the introduction of the SZX16 series, high magnification is attainable along with the added benefit of increased focal depth.

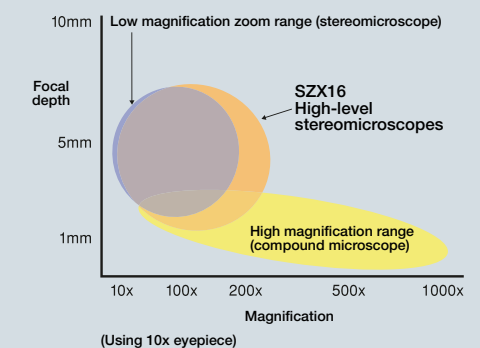



Optical performance has been refined to support the world's highest zoom range for cutting-edge research in electronic components and industrial material.

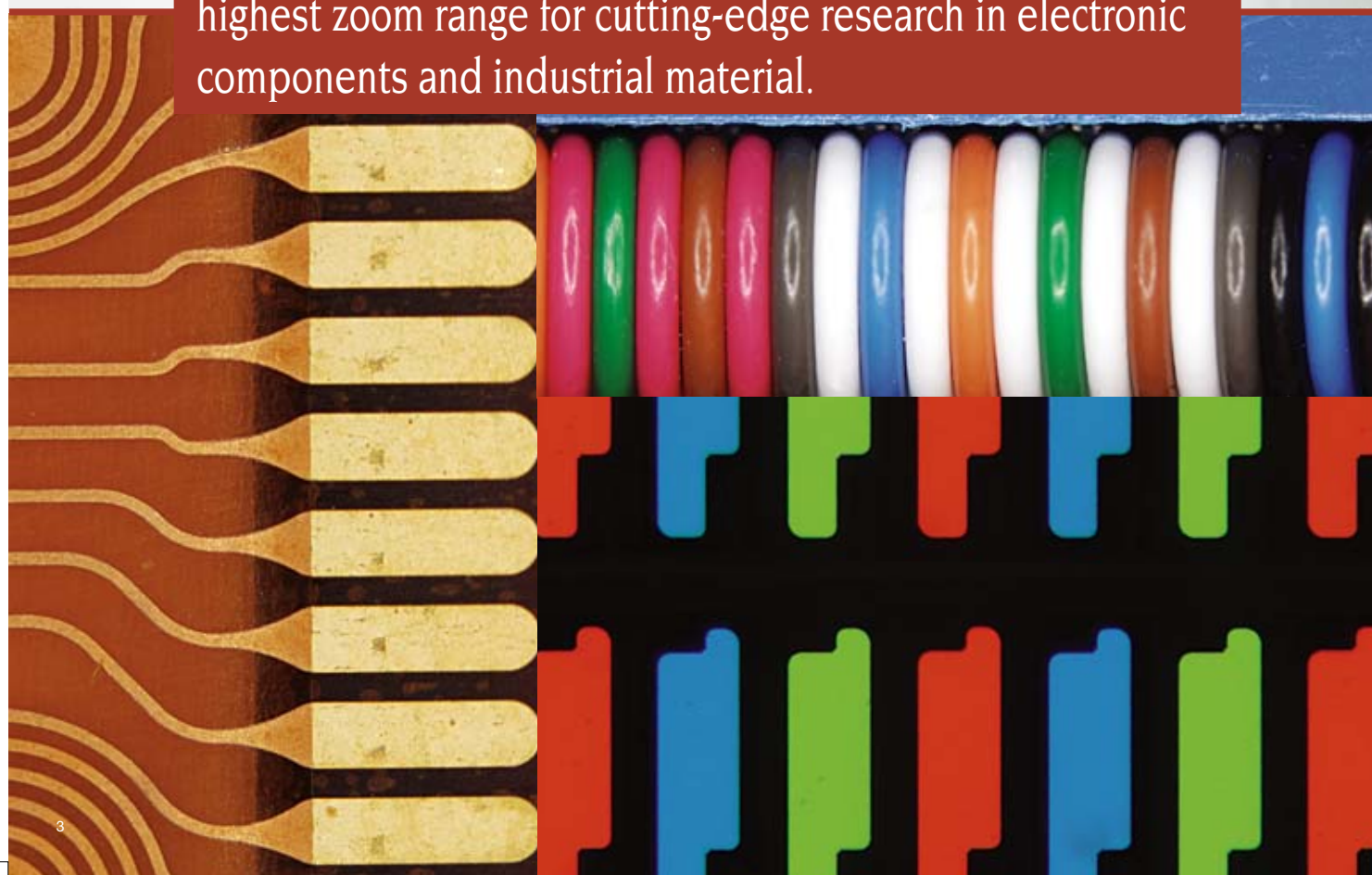

SZX16

Crystal clear viewing of specimens from large field overview to microstructural observation and the world's highest zoom ratio* (16.4:1) are key performance features.

SZX 16 represents optical performance (16.4:1 zoom ratio) at the world's highest standards. With the world's highest zoom range of 0.7x — 11.5x, clear observation ranging from overview to microstructure is possible. When revolving objectives are used, even higher resolution magnifications are available.

■ World's highest zoom ratio (16.4:1). Wide range of options for observation and documentation

At a zoom range of 0.7x – 11.5x, seamless observation of specimens from overview to minute details is realized.

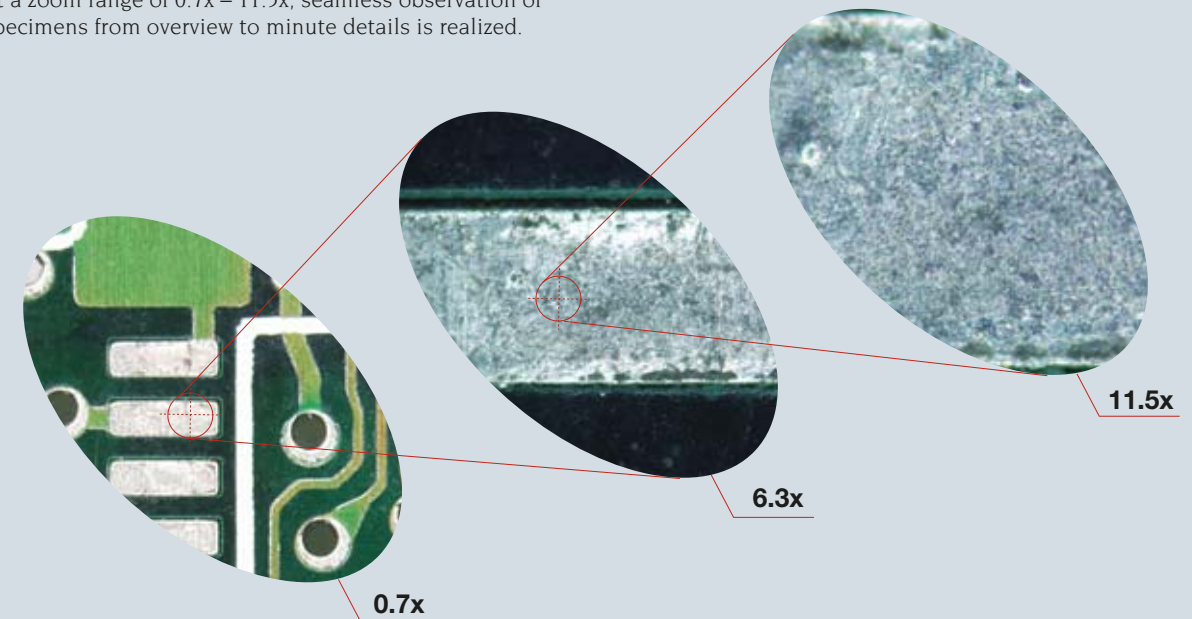

■ Unprecedented image clarity at the most frequently used magnification

Resolution at the most frequently used magnification setting (middle range) is 30% better than conventional models. Maximum brightness has been attained for the unprecedented image clarity needed for cutting-edge research in advanced materials and electronics.

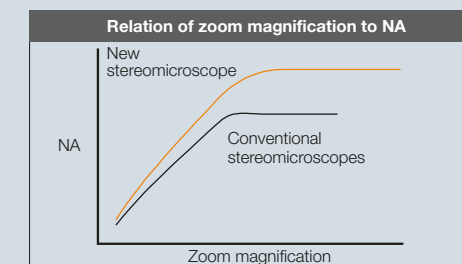

■ Expansion of zoom ratio with revolving nosepiece

The revolving nosepiece (SZX2-2RE16) incorporates parfocal (PF) objectives for observation at different magnifications. Using PF lenses enables quick and minimal focusing when switching between them.



■ Variable focus depth from the finest built-in AS zoom body for observation and image capture

The ability to control the built-in aperture stop (AS) allows the user to optimize specimen viewing for contrast and resolution and is especially useful with specimens having uneven structures.

*Olympus finding, as of March 31, 2006.

SZX16

Highly detailed viewing of specimens in true-to-life images. The new Super Depth of Focus (SDF) objectives have the world's highest resolution* and offer maximum aberration correction.

The six objectives in the new SDF lineup use special dispersion glass to provide stereoscopic viewing unmatched by other products.

■ **Newly developed SDF series and its matchless lineup**

By effectively eliminating astigmatism, the SDF series achieves high-quality stereoscopic viewing with minimal defocusing — a feature unmatched by other lenses. The six-piece lineup comprises 0.3x, 0.5x, 0.8x, 1x, 1.6x, and 2x objectives providing a wide range of observation between 2.1x-230x (with 10x eyepiece) — all conveniently available in one stereomicroscope.

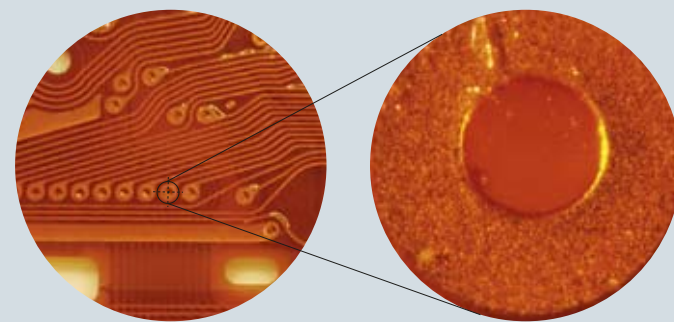

Top row, from right: SDFPLAPO2XPFC, SDFPLAPO1.6XPF, SDFPLAPO1XPF2
Bottom row, from right: SDFPLAPO0.8X, SDFPLAPO0.5XPF, SDFPLFL0.3X

Model	WD (mm)	Total magnification*
SDFPLFL0.3X	141	2.1x-34.5x
SDFPLAPO0.5XPF	70.5	3.5x-57.5x
SDFPLAPO0.8X	81	5.6x-92x
SDFPLAPO1XPF2	60	7x-115x
SDFPLAPO1.6XPF	30	11.2x-184x
SDFPLAPO2XPFC	20	14x-230x

*Using 10x eyepieces; 15x through 30x eyepieces are optional.

■ **World's highest resolution at 900 lines/mm with SDFPLAPO2XPFC**

SDFPLAPO2XPFC objectives attain the world's highest resolution at 900 lines/mm, resolved down to 1.1- μ m lines.



Conventional model

SZX16 (with SDFPLAPO2XPFC)

*Olympus finding, as of March 31, 2006.

■ **High NA (0.15) and long WD (60mm) with 1x objective**

SDFPLAPO1XPF objectives improve operability by providing both the highest numerical aperture (0.15) and longest working distance (60mm) in their class.



■ **Apochromatic design for correction of chromatic aberration**

The characteristics of the apochromatic system — integrated into tubes, zoom body, and objectives — eliminate chromatic aberration and ensure excellent color reproduction for all zoom ranges.

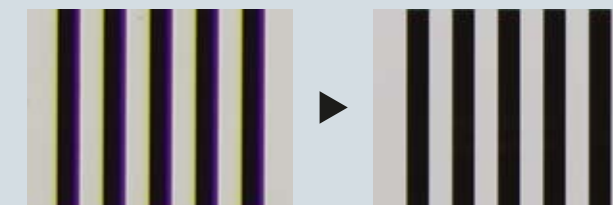

Uncorrected apochromatic viewing

Apochromatic viewing

■ **Astigmatism-free design for clear stereoscopic view**

An astigmatism-free design integrated throughout the system effectively prevents the astigmatism that deforms images appearing in heads, zoom body, and objectives. Increased focus depth enables clear observation at high magnifications.



SZX10

Superior performance and operability of this flagship model provide excellent cost efficiency and sensitive response to various specimens.

SZX10 offers high cost performance with outstanding operability. Two apochromatic objectives are standard. The 1x objective has an 81mm working distance (WD) for operational comfort, and a 0.1mm numerical aperture (NA) for assured optical performance. The 1.25x objective may be used creatively for any number of purposes. The chromatic-aberration correction of these objectives provides clear and distinct images.

■ **Highest zoom ratio (10:1) in its class**

Olympus proprietary optical design technologies are integrated to achieve a 10:1 zoom ratio that is the highest in the 0.63x - 6.3x range of its class. A wide range of magnifications is therefore possible without having to switch objectives.

■ **Built-in AS zoom body designed to be the first in its class**

The fully adjustable AS can be used to increase focus depth - especially useful when observing specimens of notable height.

■ **New 1.25x objective for high magnification and resolution; 1x objective for wider field of view and longer WD**

These high-quality apochromatic lenses designed for the SZX10 may be creatively used to serve a variety of observation tasks and needs.



Aperture stop of zoom body

Objectives: 1x for task efficiency



1.25x for high magnification and optimal NA



■ **Distortion-free design minimizes image curvature**

Distortion-free design allows for true observation of flat specimens without curvature/distortion.

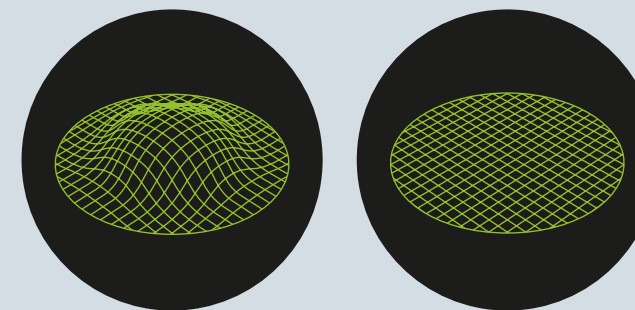

Conventional design

Distortion-free design

■ **System-wide astigmatism-free design for clear observation**

Incorporating an astigmatism-free design throughout the system effectively prevents the astigmatism that deforms head, zoom, and objective images.

■ **Selection of powerful SZX10 objectives**

Olympus objectives are designed to be equally responsive to different specimen needs. Eight SZX10 objectives offer magnification from 0.5x to 2x. Users have a variety of observation choices all in a single microscope, ranging from 3.2x to 126x with 10x eyepieces. In addition, two lenses come equipped as standard for the revolving nosepiece (SZX2-2RE10).



Top row, from right: DFPLAPO1.25X, DFPL1.5X-4, DFPL2X-4
Center row, from right: SZX-ACH1X, SZX-ACH1.25X-2
Bottom row, from right: DFPL0.5X-4, DFPL0.75X-4, DFPLAPO1X-4



Model	WD (mm)	Total magnification*
DFPL0.5X-4	171	3.2x-31.5x
DFPL0.75X-4	116	4.7x-47.3x
DFPLAPO1X-4	81	6.3x-63x
SZX-ACH1X	90	6.3x-63x
DFPLAPO1.25X	60	8.0x-80x
SZX-ACH1.25X-2	68	8.0x-80x
DFPL1.5X-4	45.5	9.5x-94.5x
DFPL2X-4	33.5	12.6x-126x

* Using 10x eyepieces; 15x though 30x eyepieces are optional.



The pursuit of fatigue-free observation through advanced ergonomics. The ergonomically designed system reduces fatigue for maximum comfort.

Tilting trinocular observation tubes with an appropriate convergence angle relieve eye and neck strain, thus eliminating fatigue and headaches.

Newly developed trinocular head for comfortable and efficient observation. Regardless of standing or seated height, observers may adjust the tilting trinocular head to efficiently perform long-duration observation.

Convergence angle in head relieves eyestrain

Recent research establishes the correlation between stereomicroscopic optical systems and eyestrain. This finding also confirms that a convergence angle using right and left optical paths without compensation can induce the malaise. The convergence angle in the SZX series, however, completely compensates for each optical path. This solution effectively eliminates eyestrain during prolonged observation.

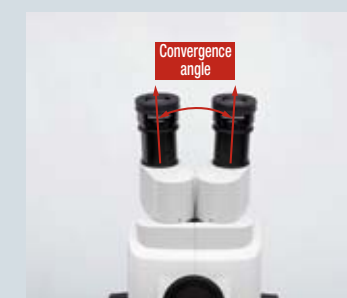

Tilting trinocular head allows for natural posture, reduces fatigue

The tilting trinocular tube, angled from 5 to 45 degrees, easily adjusts to the exact angle desired. Regardless of standing or seated height, observers can perform long-duration observations while assuming a natural posture assured by the easily adjusted tilting trinocular head. As fatigue and stress are greatly relieved, oversights are avoided and work efficiency is enhanced.



Tilting range of SZX2-TTR

Ergonomic zoom and focus knobs for fatigue-free use

Position of zoom knob, size and position of coarse/fine focusing knob, and the fine focus stroke have all been redesigned to guarantee smooth operation. This enhancement of the fine focus stroke results in easy and precise focusing.



Ergonomic coarse/fine focusing knob

Slim design illumination stand for easy access to specimens

Illumination stands are designed not only to be easy to use but fatigue-free. The slim LED transmitted light illumination stand, at approximately 40mm height, provides comfortable selection of fingertip illumination and easy access to specimens.



Slim design illumination stand (SZX2-ILLT)

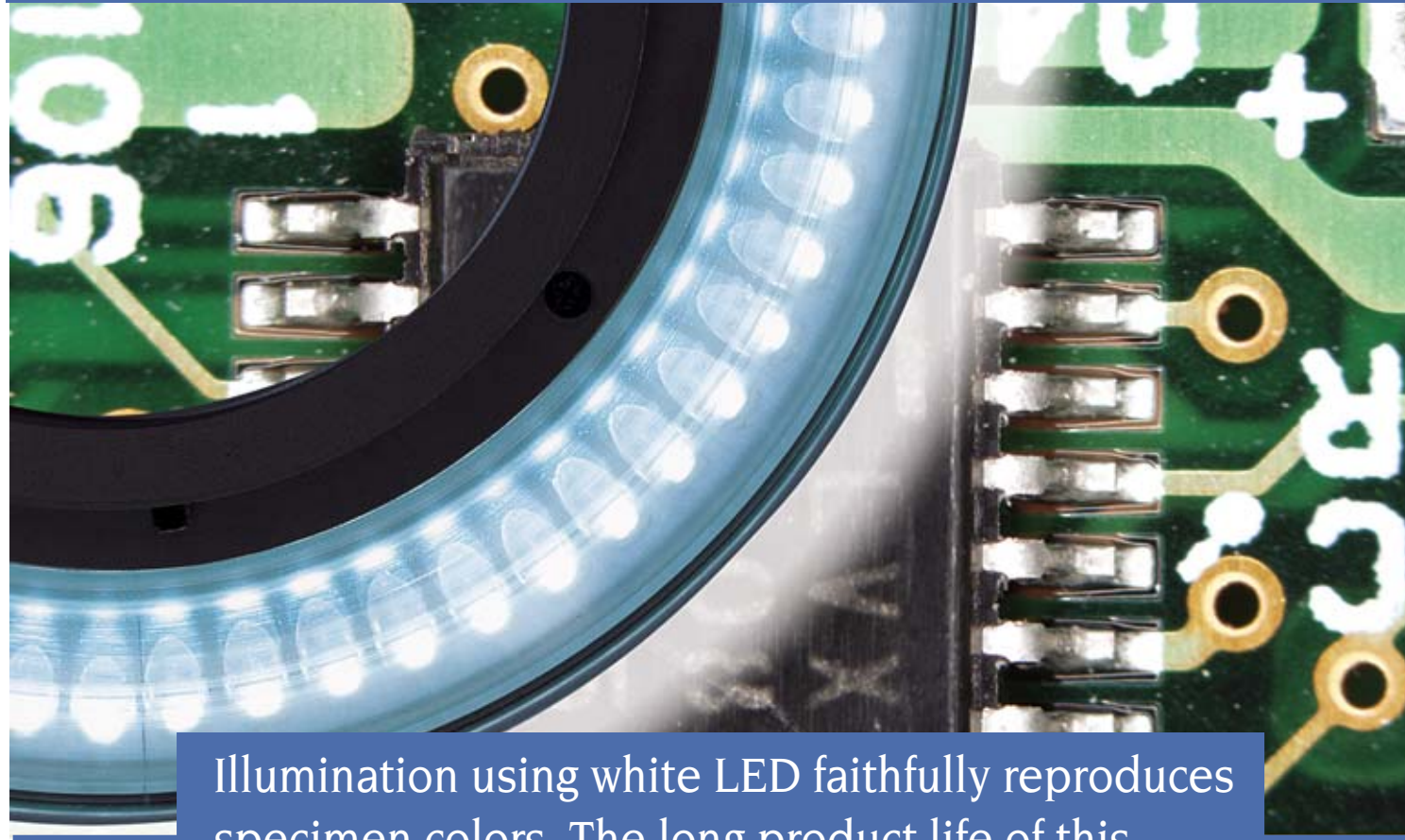

Illumination using white LED faithfully reproduces specimen colors. The long product life of this technology assures cost-effective operation.



LED: powerful, smart, long-lasting illumination for satisfying imaging

Industrial research requires the precision LED illumination can provide for a variety of inspection and sample needs. Reproducing natural light, white LED delivers constant color temperature, and the LED ring illuminator offers high contrast observation and variable lighting for ease of use. Olympus LEDs have a long life that reduces maintenance and improves imaging results.

LED Four-Part Ring Illumination Unit (SZX2-ILR66)

High-intensity LED illumination is an extremely bright light source that reproduces natural light for optimal observation. This LED illumination system provides even illumination plus a variable selection of lighting for ease of use. By choosing from an illuminator divided into four parts, offering full, 3/4, 1/2, and 1/4 lighting for a total of thirteen patterns, the user need not move the specimen for optimal viewing and documentation. Thanks to fan-less ventilation of the power supply, the LED illumination system is highly compatible with clean rooms. In addition to ESD compatibility that helps keep specimens free from static electricity damage, the manual control unit, easily operated by hand, assures user comfort.



The exclusive control for the LED ring illumination system offers the freedom to direct 13-pattern LED lighting for optimum observation. Three-quarter, half, and quarter lighting patterns move in circular rotation and in mirror symmetry via pad control. The ergonomic design of the unit is perfectly suited to fingertip operation.



SZX2-RHS, the control pad for LED 4-part ring illumination unit

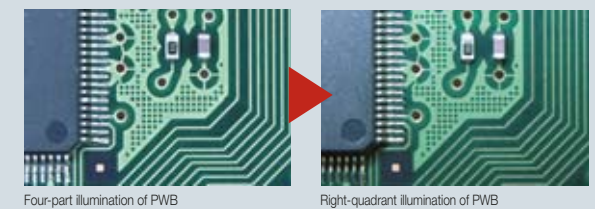
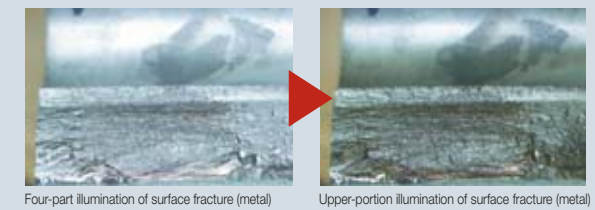

Slim LED transmitted light illumination stand (SZX2-ILLT)

This LED transmitted light illumination stand provides three image contrast options in an ultra-slim design. In addition to superior darkfield performance, LEDs with a life span of over 10,000 hours facilitate crisp brightfield images and contrast-enhancing oblique illumination.



Slim LED transmitted light illumination stand

Choose the illumination source that suits your sample

Olympus' several light solutions work in many different tasks with such sources as transmitted, reflected, ring light, and fluorescence illumination. Offering consistently bright and stable illumination, the SZX system meets reflected light requirements by a coaxial illumination system, a dual flexible light guide, and a ring light guide, among others. These choices enable users to do a broad array of stereomicroscopic observations and documentation.

■ Various reflected light illumination systems

Dual combination light guide (LG-DFI)

The top-mounted dual light guide is very easy to position and keeps workspace uncluttered. This system maintains the selected illumination position when focusing.



SZX16 Coaxial illuminator



Dual contrast light guide on SZX16

Coaxial illumination system (SZX2-ILLC16/SZX2-ILLC10)

This illumination system is ideal for detecting imperfections on highly reflective samples such as ICs, photonic products, and medical devices.

Dual inter-lock light guide (LG-DI)

With this unit, pinpoint accuracy of select areas may be observed in detail under optimal viewing conditions.



Ring light guide (LG-R66)

This ring light guide provides bright, clear, and uneven illumination from several angles, thus eliminating obstructive sample shadowing.



Ring light guide on SZX16

Objectives with an access angle of 51 degrees (objectives for SZX16: SDFPLAPO1.6XPF, SDFPLAPO2XPFC)

In the past, conventional light guides with short WD objectives made effective illumination difficult. Objectives set at 1.6x and 2x, with a 51-degree access angle, enable optimum illumination.



■ Transmitted light illumination in the following three stands

Advanced brightfield transmitted light illumination stand with filters (SZX2-ILLB)

Exceptional contrast for transparent samples is achieved through a unique oblique illumination design. Further contrast enhancement is optimized for both high- and low-power imaging. Three built-in filters (ND6/ND25/LBD) deliver stable color temperature illumination.



Advanced transmitted light illumination stand (SZX2-ILLB)

Brightfield/darkfield transmitted light illumination stand (SZX2-ILLD)

This transmitted light illumination stand provides twice the usual intensity with even illumination, while maintaining a safe temperature level on the surface of the illumination stand.



Transmitted light illumination stand (SZX2-ILLK)

Distinguished cost-effective performance that is especially suitable for 1x objectives. Adjustable oblique illumination provides the contrast needed for optimal observation of transparent specimens.



SZX16-FRA Fluorescence light illumination system for advanced fluorescence imaging

Highest NA among stereomicroscopes provides extraordinarily bright fluorescent observation

Newly designed near-vertical reflected light illumination system produce illumination that is almost coaxial to the observation path and allow for substantially improved excitation light efficiency. These features provide an average of two to three times better fluorescent observation than conventional stereomicroscopes at all magnifications. In addition to using reflected light, transmitted light can be also be used for specimen confirmation.

Five-position turret with five-filter selection

Fluorescence illumination system for the SZX16 have five-position turrets with a five-filter selection for different specimens. Eleven different fluorescent filter units capture the details of bright and high-contrast fluorescent images.



Sophisticated microscope digital camera and image analysis software support a multitude of operations including observation, report generation and database archiving.

Olympus microscope digital camera captures SZX images in high resolution

OPTO-DIGITAL Technology is a total synergy of the latest digital technologies from Olympus: proprietary technology for optics, microscope digital camera, and image analysis software. Vertical observation provides excellent images.

High-resolution microscope digital camera (DP71)* offering 12.5 megapixels

Thanks to its high-speed hardware, images equivalent to 12.5 million pixels can be captured in about three seconds. The live image is displayed in 15fps (frames per second) at maximum. The camera's high sensitivity (ISO1600) clearly detects slight differences of color and microscopic scarring.



High performance 5 megapixel color digital camera (DP25)*

Thanks to Olympus original color profiling technology, the camera materializes natural color reproduction of live and archived images. It also enables faithful real time images at fast frame rate in high resolution. Five megapixel profiling guarantees outstanding high resolution image archiving. IEEE format assures easy connection to PC.

*Available from October 2006

High-speed, compact color digital camera (DP20)

One touch of the control box button to capture images numbers among the user-friendly features. The compact body is 25% smaller than most PC-type digital cameras. This means little space is needed for inspection device setup. Live images are displayed in the fine UXGA format at a maximum of 20 fps.



Vertical observation

The revolving nosepieces for SZX16 (SZX2-2RE16) and SZX10 (SZX2-2RE10) may be used for standard stereoscopic observation as well as vertical observation, which accommodates the overlap of lens center and optical axis. Lens-centered observation results in aberration-free images. Defocusing is therefore effectively eliminated for 3D rendering by image processing software.

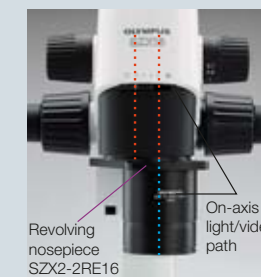

The nosepiece enables vertical observation.



Ordinary observation (image)



Vertical observation

* PC is not included with the digital camera system.

analySIS FIVE: flexible image analysis solution for all microscopy and image-processing applications



3D images

This function generates realistic 3D animation. Images acquired by extended focus can be rendered into 3D, and structured 3D images can be enlarged, minimally sized, transferred, and rotated. A comprehensive view of specimens is therefore available to users.

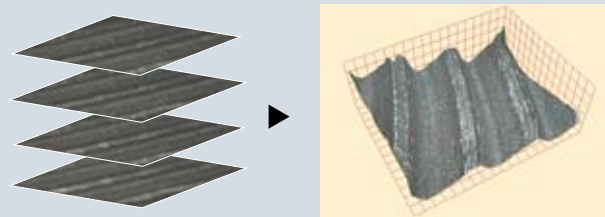

Extended focus

This function synthesizes images of different focus into one image. Even observations of specimens with vertical elevation can be integrated into one vivid image.

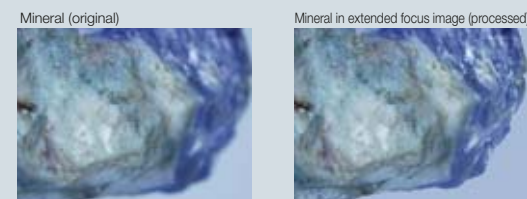

Measurement

Such measurement functions as sum calculation, point-to-point distancing, and area measurement may be performed manually. Statistical analysis is performed automatically on measurement results. Measurement, statistical analysis, and captured images can be stored and printed.

Stitching of images

Adjoining multiple images can be merged and synthesized ("stitched") into one natural image. This enables a wider range of observation options, not possible on standard microscopes, to be done as one unified process.

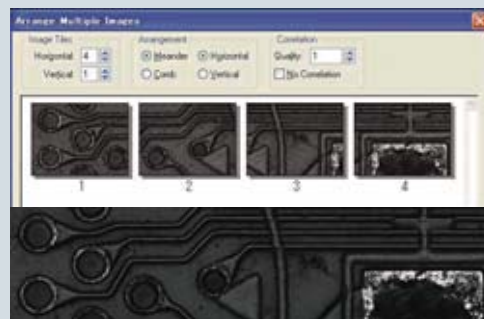

Database

Database hierarchy is displayed on the screen for integration of captured images and analysis results into a database or for systematic creation of graphs for comprehensive data analysis. Search function also allows quick access to necessary data.

Report generator

This image analysis software also generates clear and easy-to-read reports because of its flexible solutions for layout and image editing. Besides the standard setting, users can set their own formats to match their needs.

Digital camera/microscope control

This software enables direct control and operation of digital cameras mounted on the stereomicroscope. By mounting the motorized focusing unit (SZX2-FOA2), focusing can be done from a PC.

Note: PC control of SZX2-FOA is available from late 2006.

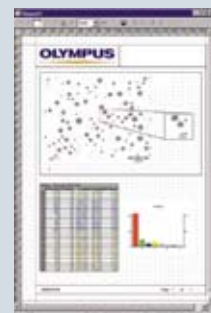

Menu recipe of report generator



A wide range of accessories to extend the width of observation. Customizable for various purposes. (SZX16 / SZX10)



SZX16 Universal stand



SZX16 Large stand



SZX16 Motorized zoom and focus unit

Universal stand with ESD* compatibility (SZX-STU2)

This stand is designed for observation and digital imaging of specimens too large for standard-size stands. The design, based on dual horizontal poles and linear ball bearings, ensures smooth horizontal movement and rotation. The mechanism can be tilted forward, backward, right and left, allowing a quick and precise approach to the chosen observation area.

*ESD = Electric Static Discharge

Large stand (SZX2-STL)

This large stand exhibits excellent stability, making it highly suitable for photomicrography as well as observation of large specimens.

Motorized zoom and focus unit (SZX-FOA2)

Foot or hand switch with PC control of motorized zooming/focusing allows the observer to concentrate on operation, improving overall work efficiency during observation and recording. This also enhances 3D-image rendering via image processing software. Easy handling extends to installation of a large photomicrography unit weighing 14kg. Another advantage of this unit is that the observer can stand away from the microscope for monitor observation. Manual coarse focusing and fine focusing are both possible when motorized control is engaged.



U-SRG, SZX-STAD1

BX stage adapter type 1 (SZX-STAD1)

Allows use of the BX2M rotating stage (U-SRG) to various SZX stands and transmitted light illuminators. This is especially valuable in polarized observations and photomicrography.

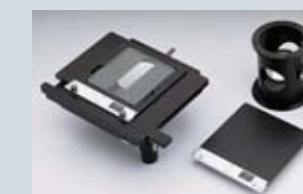

U-SIC4R2, U-MSSPG, U-MSSP4, SZX-STAD-2

BX stage adapter type 2 (SZX-STAD2)

Allows use of a BX2M mechanical stage by combining with various SZX stands and transmitted light illuminators. Particularly suitable for accurate X-Y movement of specimens.



BH2-SH, SZH-STAD1

BH stage adapter type 1 (SZH-STAD1)

Allows use of a BH2 mechanical stage (BH2-SH) by combining with various SZX stands and transmitted light illuminators. Particularly suitable for accurate X-Y movement of specimens.



SZX16 System Diagram

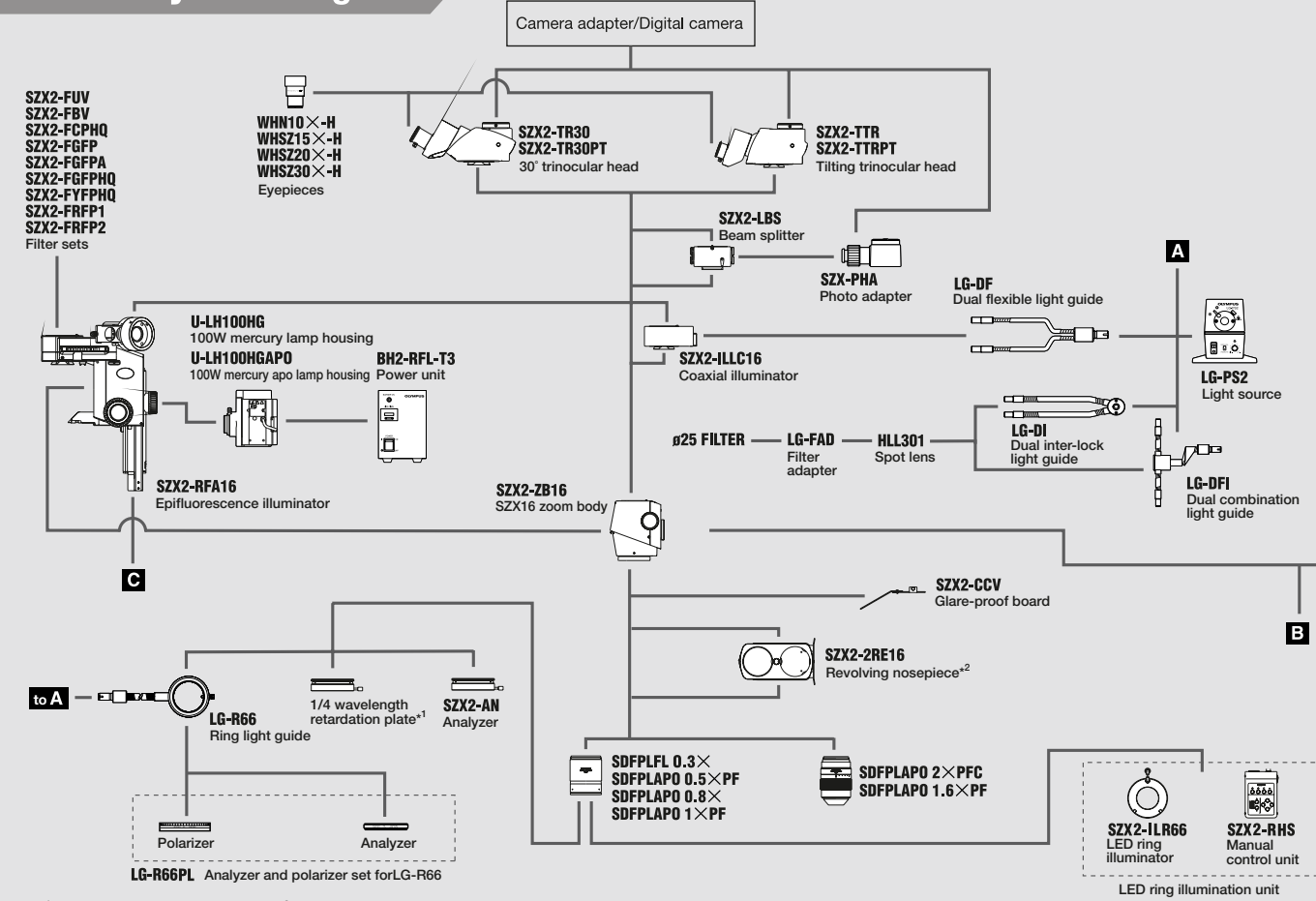

*1 Incorporated in SZX2-ILLC16 *2 Cannot be attached to SZX2-FO

SZX10 System Diagram

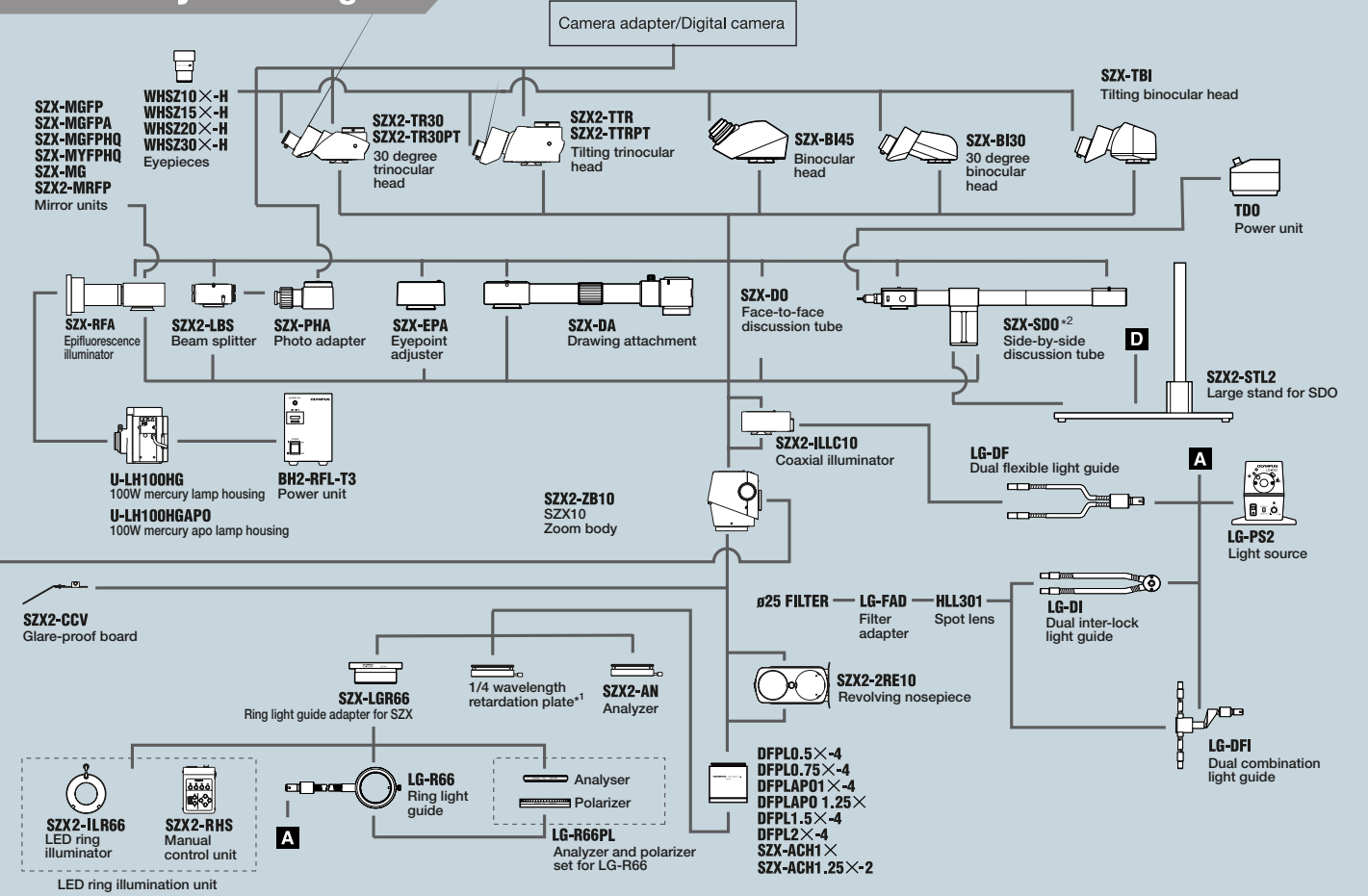

*1 Incorporated in SZX2-ILLC10 *2 The SZX2-FOFH is highly recommended for SZX2-SDO use focusing unit.

Accessories

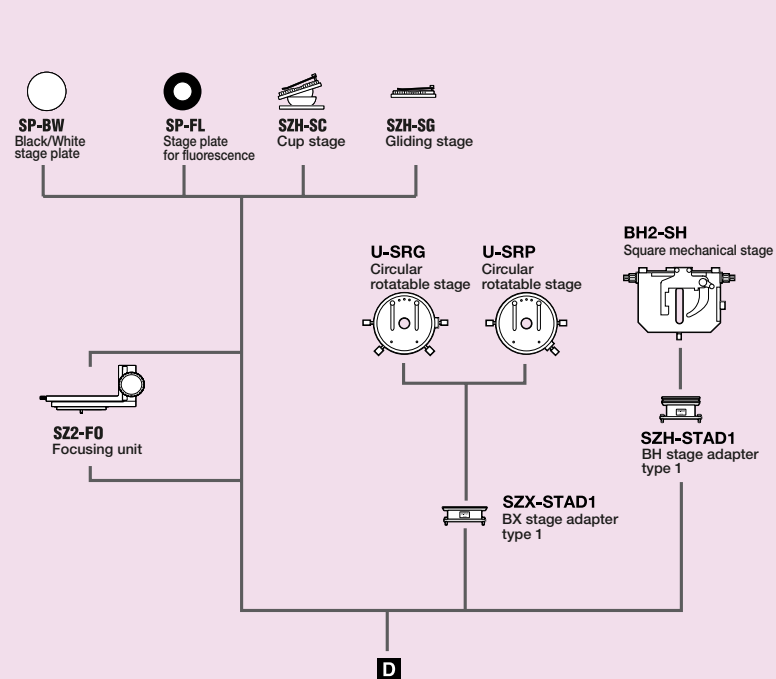

Focusing units

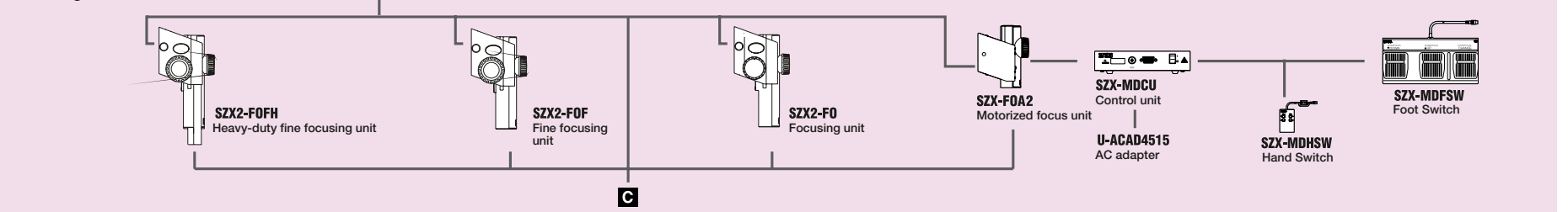

Illuminators

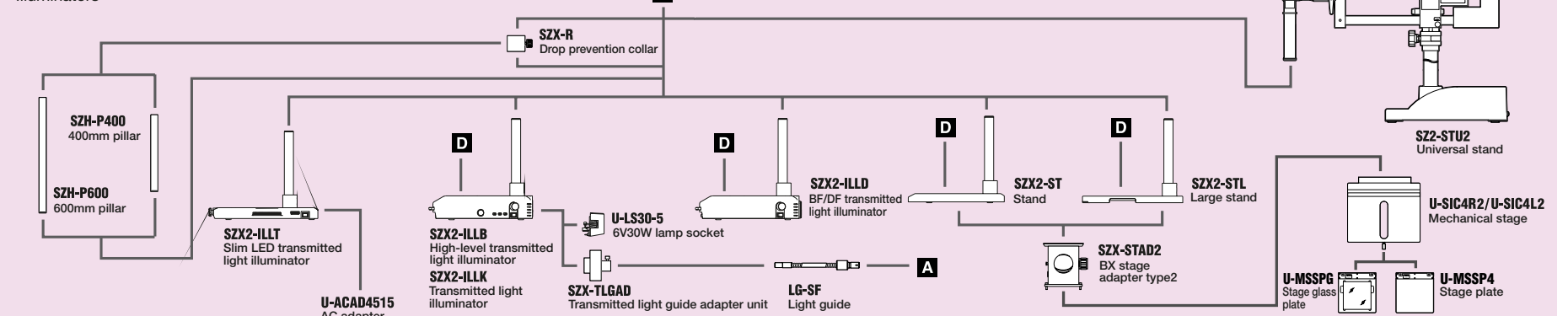

SZX16/SZX10 specifications

Item	Specifications					
	SZX16			SZX10		
Zoom microscope bodies	Zoom ratio: 16.4-1 (0.7x-11.5x) Magnification indication: 0.7/0.8/1/1.25/1.6/2/2.5/3.2/4/5/6.3/8/10/11.5			Zoom ratio: 10-1 (0.63x-6.3x) Magnification indication: 0.63/0.8/1/1.25/1.6/2/2.5/3.2/4/5/6.3		
	Zoom variable magnification system with parallel optical axis Zoom drive system: Horizontal handle Click-stop for various zoom positions incorporated					
	Built-in AS zoom body					
	Objective mounting: screw mount					
Objective *With WHN10x-H/ WHSZ10-H	For SZX-ZB16			For SZX-ZB10		
	Objectives	N.A.	W.D. (mm)	Objectives	N.A.	W.D. (mm)
	SDFPLFL0.3X	0.045	141	DFPL0.5X-4	0.05	171
	SDFPLAPO0.5XPF	0.075	70.5	DFPL0.75X-4	0.075	116
	SDFPLAPO0.8X	0.12	81	DFPLAPO1X-4	0.1	81
	SDFPLAPO1XPF	0.15	60	SZX-ACH1X	0.1	90
	SDFPLAPO1.6XPF	0.24	30	DFPLAPO1.25X	0.125	60
	SDFPLAPO2XPF	0.3	20	SZX-ACH1.25X-2	0.125	68
Eyepiece	WHN10X-H F.N. 22 WHSZ15X-H F.N. 16 WHSZ20X-H F.N. 12.5 WHSZ30X-H F.N. 7			WHSZ10X-H F.N. 22 WHSZ15X-H F.N. 16 WHSZ20X-H F.N. 12.5 WHSZ30X-H F.N. 7		
	SZX2-TTR/SZX2-TTRPT: Tilting trinocular head Convergence angle, Tilting angle: 5°-45°, ray switcher: 2 ways (TTR: binocular100%, binocular50%, camera50%, TTRPT: binocular100%, camera100%) Interpupillary distance adjustment: 52-76mm					
	SZX2-TR30/SZX2-TR30PT: 30 degree trinocular head Convergence angle, Tilting angle: 30°, ray switcher: 2 ways (TR30: binocular100%, binocular50%, camera50%, TR30PT: binocular100%, camera100%) Interpupillary distance adjustment: 52-76mm					
	SZX-BI30: 30° binocular head Tilting angle: 30° Interpupillary distance adjustment: 51-76					
SZX-BI45: 45° binocular head Tilting angle: 45° Interpupillary distance adjustment: 52-76						
SZX-TBI: tilting binocular head Tilting angle: 5-45° Interpupillary distance adjustment: 51-76						
Focusing assembly:	SZX2-FO: Focusing unit / focus: rack and pinion with roller guide (with torque adjustment ring for focusing), optional counter balance, coarse handle stroke: 80mm, coarse handle stroke per rotation: 21mm, Load capacity: 0-10.0kg					
	SZX2-FOF: Fine focusing unit / focus: rack and pinion with roller guide (with torque adjustment ring for coarse focusing), coarse and fine coaxial handle, built-in counter balance, coarse handle stroke: 80mm, coarse handle stroke per rotation: 36.8mm, fine handle stroke: 80mm, fine handle stroke per rotation: 0.77mm, load capacity: 2.7-15.0kg					
	SZX2-FOFH: Heavy-duty fine focusing unit / focus: rack and pinion with roller guide (with torque adjustment ring for coarse focusing), coarse and fine coaxial handle, built-in counter balance, coarse handle stroke: 80mm, coarse handle stroke per rotation: 36.8mm, fine handle stroke: 80mm, fine handle stroke per rotation: 0.77mm, load capacity: 8.0-25.0kg					
	SZX-FOA2: Motorized focus unit / focus: rack and pinion with roller guide (with torque adjustment ring for coarse focusing), focusing stroke: 75mm, motorized focusing speed coarse: 1.5mm/sec fine: 0.3mm/sec load capacity: 2.7-15.0kg					
Stands	SZX-ST: Stand / Pillar height: 270mm, base dimension: 284(W)x335(D)x31(H)mm, Stage clips are mountable, with stage adapter fixing screw holes					
	SZX2-STL: Large stand / Pillar height: 400mm, base dimension: 400(W)x350(D)x28(H)mm, Stage clips are mountable, with stage adapter fixing screw holes					
Environment	In-house use / altitude: till 2000 m high, temperature: 5 through 40 degrees Centigrade, humidity: Max 80% (at or below 31 degree Centigrade, the figure varies in other temperature.)					

Transmitted illuminators specifications

Item	Specifications			
	SZX2-ILLT	SZX2-ILLB	SZX2-ILLK	SZX2-ILLD
Light source	LED	6V30W Halogen 6V30W HAL PHILIPS 5761 (average lamp service life: approx. 100 hours)		
Light intensity adjustment	Continuously variable system			
Effective illuminated area	Brightfield: ø63mm Darkfield / Oblique: ø35mm	ø40mm		Brightfield: ø40mm Darkfield: ø35mm
Built-in filter	---	LBD, ND6, ND25 one for each	---	LBD (inter-lock brightfield)
Add-on filter	---	---	ø45mm frosted filter (45LBD), provided	---
Illumination mode	Brightfield illumination Oblique illumination Darkfield illumination	Brightfield illumination Oblique illumination	Brightfield illumination Oblique illumination	Brightfield illumination Darkfield illumination
Contrast selection	---	2-step selection of High and Low		---
Cooling fan	---	Built-in		
The height of stage (from desk surface)	41mm	82mm		
Pillar height	270mm			
Weight	Approx. 3.7kg	Approx. 5.0kg	Approx. 4.6kg	Approx. 5.4kg
Power source	AC adaptor	Built-in trance power unit		

Reflected light illuminators specifications

Type	LED ring illuminator SZX2-ILR66	Ring light guide LG-R66	Dual ring light guide LG-DFI/DI	Coaxial illuminator SZX2-ILLC16/10
Features	4-part LED ring illumination 4-part independent ON/OFF available	Bright, uniformly lit images without glaring reflections or obscuring shadows	Flexible illumination for any angle and position	Bright high contrast coaxial illumination. Effective for observing structure, such as imperfections on metal surfaces, patterns on IC or LCD
Specifications	Rotary, mirror function, ESD capability, RoHS compatibility, Class 1	Minimum WD: 30mm Installation diameter: 66mm Flexible part: 1000mm Attachment adapter*: SZX-LGR66 <small>*No adapter required for SZX16-LGR66 *Unable to attach to SDFPLAPO2XPF/SDFPLAPO16XPF</small>	LG-DFI: Flexible part 900mm Inter-lock part 500mm LG-DI: Inter-lock part 500mm	Magnification factor: 1.5x Light guide: LG-DF Flexible part 1000mm 1/4 wave plate
Light source specifications	10-segment light intensity volume, fan-less ventilation, AC100-240V	Type: LG-PS2 Functions: Light intensity control and lamp ON/OFF control by external signal (DCO-5V), mechanical adjustment function Power consumption: 150W (350VA) Rated voltage: 100-120V/220-240V 50/60Hz Dimensions: 120(H)x120(H)x235(D)mm Weight: approx. 1.5kg		
Option	SZX-LGR66, adapter for SZX10	LG-R66PL: Polarizer/analyzer set for LG-R66	HILL301: spot lens LG-FAD: ø25 filter adapter	

Total magnifications and actual field diameters of SZX2-ZB16

Objective	Eyepiece							
	WHN10X-H		WHSZ15X-H		WHSZ20X-H		WHSZ30X-H	
	total mag.	field diameter (mm)	total mag.	field diameter (mm)	total mag.	field diameter (mm)	total mag.	field diameter (mm)
SDFPLFL0.3X	2.1x-34.5x	ø104.8-ø6.4	3.2x-51.8x	ø76.2-ø4.6	4.2x-69x	ø59.5-ø3.6	6.3x-103.5x	ø33.3-ø2.0
SDFPLFL0.5XPF	3.5x-57.5x	ø62.9-ø3.8	5.3x-86.3x	ø45.7-ø2.8	7x-115x	ø35.7-ø2.2	10.5x-172.5x	ø20.0-ø1.2
SDFPLAPO0.8X	5.6x-92x	ø39.3-ø2.4	8.4x-138x	ø28.6-ø1.7	11.2x-184x	ø22.3-ø1.4	16.8x-276x	ø12.5-ø0.8
SDFPLAPO1XPF	7x-115x	ø31.4-ø1.9	10.5x-172.5x	ø22.9-ø1.4	14x-230x	ø17.9-ø1.1	21x-345x	ø10.0-ø0.6
SDFPLAPO1.6XPF	11.2x-184x	ø19.6-ø1.2*	16.8x-276x	ø14.3-ø0.9	22.4x-368x	ø11.2-ø0.7	33.6x-552x	ø6.3-ø0.4
SDFPLAPO2XPF	14x-230x	ø15.7-ø1*	21x-345x	ø11.4-ø0.7*	28x-460x	ø8.9-ø0.5	42x-690x	ø5.0-ø0.3

Some vignetting may occur from optical characteristics. This occurs in observations at low magnification.

Total magnifications and actual field diameters of SZX2-ZB10

Objective	Eyepiece							
	WHSZ10X-H		WHSZ15X-H		WHSZ20X-H		WHSZ30X-H	
	total mag.	field diameter (mm)	total mag.	field diameter (mm)	total mag.	field diameter (mm)	total mag.	field diameter (mm)
DFPL0.5X-4	3.2x-31.5x	ø69.8-ø7.0	4.7x-47.3x	ø50.8-ø5.1	6.3x-63x	ø39.7-ø4	9.5x-94.5x	ø22.2-ø2.2
DFPL0.75X-4	4.7x-47.3x	ø46.6-ø4.7	7.1x-70.9x	ø33.9-ø3.4	9.4x-94.5x	ø26.5-ø2.6	14.2x-141.8x	ø14.8-ø1.5
DFPLAPO1X-4 SZX-ACH1X	6.3x-63x	ø34.9-ø3.5	9.5x-94.5x	ø25.4-ø2.5	12.6x-126x	ø19.8-ø2	18.9x-189x	ø11.1-ø1.1
DFPLAPO1.25X SZX-ACH1.25X-2	7.9x-78.9x	ø27.9-ø2.8	11.8x-118.1x	ø20.3-ø2	15.8x-157.5x	ø15.9-ø1.6	23.6x-236.3x	ø8.9-ø0.9
DFPL1.5X-4	9.5x-94.5x	ø23.3-ø2.3	14.2x-141.8x	ø16.9-ø1.7	18.9x-189x	ø13.2-ø1.3	28.4x-283.5x	ø7.4-ø0.7
DFPL2X-4	12.6x-126x	ø17.5-ø1.7	18.9x-189x	ø12.7-ø1.3	25.2x-252x	ø9.9-ø1	37.8x-378x	ø5.6-ø0.6

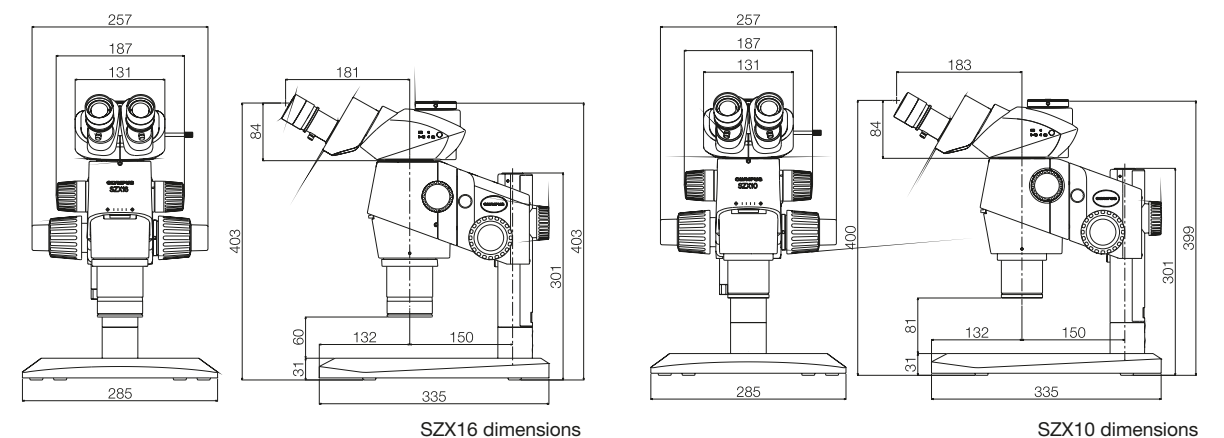

SZX16 dimensions

SZX10 dimensions